

Instruction Manual

Installation • Operation • Maintenance



Caterpillar Generator AVR VR6

K65-12B

K125-10B

Ruitai industry Co.,Ltd.

Tel: +86 577 80221899

Fax: +86 577 56667563

Email: sales@china-avr.com

www.china-avr.com

Table of Contents

Introduction.....	3
Foreword.....	3
Safety Instructions.....	3
General Information.....	3
General.....	3
Specifications.....	4
Installation.....	6
Mounting.....	6
Connections.....	7
Operation.....	13
General.....	13
Preliminary Setup.....	13
System Startup.....	13
Adjustments.....	15
Field flashing.....	15
Frequency roll-off adjustment.....	15
Stability (STB).....	16
Voltage (VLT ADJ) adjustment.....	16
Factory voltage adjust range calibration adjustment.....	16
Parallel drop (DRP) compensation.....	16
Options.....	16
Remote voltage adjust.....	16
Excitation disable.....	17
VAR/PF control.....	17
Manual voltage control.....	17
Operational Test.....	17
Maintenance.....	19
Preventive.....	19
Troubleshooting.....	19

Note: *Because of rapid changes in designs and processes and the variability of Kato Engineering's products, information in this manual must not be regarded as binding and is subject to change without notice.*

Introduction

Foreword

This manual contains instructions for installing, operating and maintaining Kato Engineering K65-12B and K125-10B voltage regulators.

Safety Instructions

In order to prevent injury or equipment damage, everyone involved in installation, operating and maintenance of the equipment described in this manual must be qualified and informed of the current safety standards that govern his or her work. The following paragraphs define warnings, cautions, and notes as they are used in this manual:

Warning: Warnings identify an installation, operating or maintenance procedure, practice, condition, or statement that, if not strictly followed, could result in death or serious injury to personnel.

Caution: Cautions identify an installation, operating or maintenance procedure, practice, condition, or statement that, if not strictly followed, could result in destruction of or damage to equipment or serious impairment of system operation.

Note: Notes highlight an installation, operating or maintenance procedure, condition, or statement and are essential or helpful but are not of known hazardous nature as indicated by warnings and cautions.

General Information

General

The K65-12B and K125-10B Voltage Regulators are contained in an encapsulated plastic case. The regulator controls the DC exciter field power of conventional, 50 or 60 Hz brushless generators.

Regulation is provided by sensing the generator output voltage, converting it to a DC signal and comparing the signal to a reference voltage signal. An error signal is developed and used to control the DC field power in order to maintain a constant generator output.

The regulator includes frequency compensation with selectable slope, inverse time over-excitation shutdown, solid-state build-up circuitry, single-phase or three-phase voltage sensing, single-phase or three-phase shunt, or permanent magnet power input, and parallel droop compensation, and an accessory input. The accessory input provides compatibility with accessories such as a var/power factor controller.

Warning: *To avoid personal injury or equipment damage, only qualified people should perform the procedures described in this manual.*

Warning: *Use meggers and high-potential test equipment with extreme care. Incorrect use can damage components.*

Specifications

Refer to Table 1 for the electrical specifications. Refer to Table 2 for the physical specifications:

Specification	K65-12B	K125-10B
Output power (with a 240 Vac Input):	12 Adc @ 65 Vdc maximum continuous. 25 Adc @ 125 Vdc forcing for 10 seconds.	10 Adc @ 125 Vdc maximum continuous. 20 Adc @ 250 Vdc forcing for 10 seconds.
AC input power:	100 to 280 Vac, single-phase 50 to 400 Hz, or 63 to 105 Vac; three-phase, 50 to 400 Hz, 1092 VA maximum continuous burden	180 to 280 Vac, single-phase or three-phase, 50 to 400 Hz, 1750 VA maximum continuous burden
AC sensing voltage:	90 to 140 Vac, 50/60 Hz; single- or three-phase.	90 to 140 Vac, 50/60 Hz; single- or three-phase.
External voltage adjust rheostat:	10k ohm, 2 W, potentiometer	10k ohm, 2 W, potentiometer
Regulation accuracy:	±0.5% Average responding	±0.5% Average responding
Voltage drift:	±1% voltage variation for a 40° C (104° F) change.	±1% voltage variation for a 40° C (104° F) change.
Response time:	< 4 milliseconds	< 4 milliseconds
Frequency compensation:	1 or 2 V/Hz jumper selectable with knee adjustable from 45 Hz to 65 Hz.	1 or 2 V/Hz jumper selectable with knee adjustable from 45 Hz to 65 Hz.
EMI suppression:	Internal filter	Internal filter
Voltage Build-Up:	Internal provisions for automatic voltage build-up from generator residual voltages as low as six Vac.	Internal provisions for automatic voltage build-up from generator residual voltages as low as six Vac.
Overexcitation shutdown:	Overexcitation protection starts timing at 90 Vdc ±5% and takes the output to zero in greater than 30 seconds. The output can be 125 Vdc for greater than 10 seconds.	Overexcitation protection starts timing at 180 Vdc ±5% and takes the output to zero in greater than 30 seconds. The output can be 250 Vdc for greater than 10 seconds.
Droop	1 A or 5 A, <10 VA, adjustable from 0 to 10% at rated input current, 0.8 power factor	1 A or 5 A, <10 VA, Adjustable from 0 to 10% at rated input current, 0.8 power factor
UL recognized/CSA certified	UL Recognized per Standard 508, UL File NO. E97035. CSA certified per Standard CAN/CSA-C22.2 No. 14-95, CSA File No. LR 23131	UL recognized per Standard 508, UL File NO. E97035. CSA certified per Standard CAN/CSA-C22.2 No. 14-95, CSA File No. LR 23131

Table 1: Electrical specifications

Specification	K65-12B and K125-10B
CE conformity	Conforms to: Radiated Emissions..... EN50081-2 Radiated Immunity: Electric field..... EN61000-4-3 (10 V/m) Conducted..... EN61000-4-6 (10 VRMS) Conducted Emissions..... EN50081-2 (EN55011, Class A) ESD Immunity..... EN50082-2 (4 kV contact, 8 KV air) EFT Immunity EN50082-2 (2 kV coupling clamp) Magnetic Immunity EN50082-2 (30ARMS, 50 Hz) Safety EN61010-1 (When enclosed within a suitable steel enclosure attached the generator)
Operating and storage temperature:	-40° C (-40° F) to +70° C (+158° F).
Shock:	Withstands up to 20 g in each of three mutually perpendicular axes.
Vibration:	Withstands the following accelerations at the stated frequency: 0.5 g; 18 to 2000 Hz
Weight:	Approximately 1.1 kg (2.5 lbs.)

Table 2: Physical specifications

Installation

Mounting

The regulator may be mounted in any position. Refer to Figure 1 for overall dimensions. The regulator may be mounted directly on the generator set using UNF 1/4-20 or equivalent hardware. Select the proper hardware to withstand any expected shipping/transportation and operating conditions.

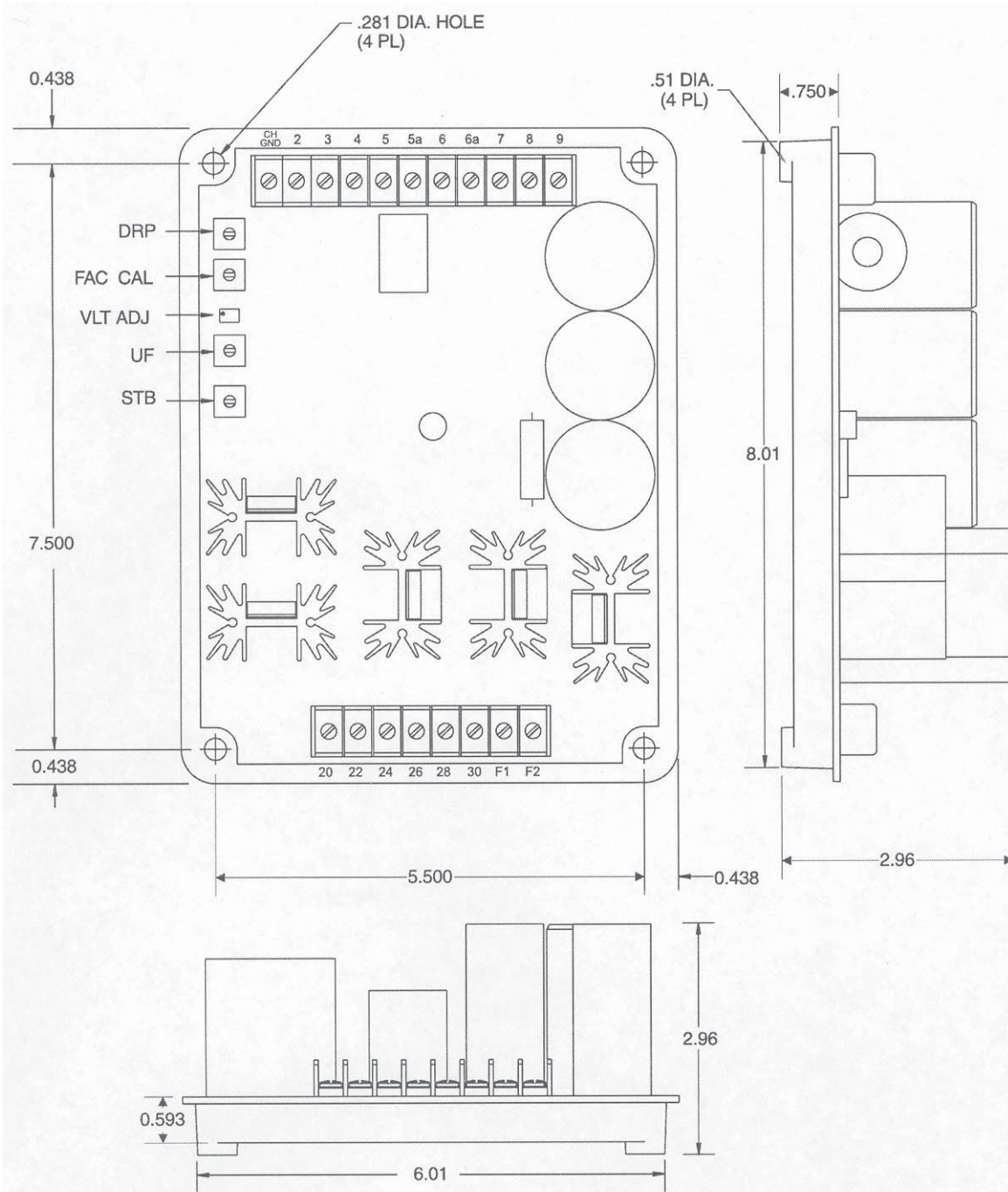

Figure 1: Outline drawing

Connections

Before connecting the K65-12B and K125-10B into your system, review the terminal descriptions provided in Table 3, the internal adjustments provided in Table 4, and the typical interconnection diagrams shown in Figures 2-6.

Terminal number	Terminal description
<u>Upper Terminal Strip</u>	
CH GND	Chassis ground connection
2	Auxiliary input from var power factor controller
3	Auxiliary input from var power factor controller
4	Connect to 7 to use internal voltage adjust, no connection for external voltage adjust
5	1 A current transformer
5a	5 A current transformer
6	Current transformer common
6a	Common connection for selectable features
7	Connect Remote Adjust from 7 to 6a, connect to 4 for internal voltage adjust
8	Connect to 6a to select 1v/Hz underfrequency slope (Not 810-34334-00)
9	Connect to 6a to select 3 phase sensing
<u>Lower Terminal Strip</u>	
20	Phase C sensing input
22	Phase A sensing input
24	Phase B sensing input
26	3-phase power input
28	1-phase or 3-phase power input
30	1-phase or 3-phase power input
F1	Field +
F2	Field -

Table 3: Terminal descriptions

Adjustment	Adjustment description
DRP	Voltage droop adjust
FAC CAL	FAC CAL is a factory voltage adjust range calibration. No customer adjustment is required.
VLT ADJ	Multi-turn voltage adjust
UF	Underfrequency knee adjust (Not 810-34334-00)
STB	Stability adjust

Table 4: Internal adjustments

NOTES:

- 1 IF 1A. SEC CCCT IS USED, CONNECT TO TERMINAL 5 INSTEAD OF 5a. (VAR/PFC & EL CANNOT BE USED WITH 1A. CCCT).
- 2 IF EXTERNAL VAR IS NOT USED, JUMPER 4 TO 7.
- 3 FOR 2 x V/HZ, REMOVE CONNECTION TO TERMINAL 8. (1 x V/HZ CONNECTION IS SHOWN).
- 4 IF EL, VAR/PF, DSLC AND/OR BE3-25A ARE NOT USED, JUMPER 2 TO 3.

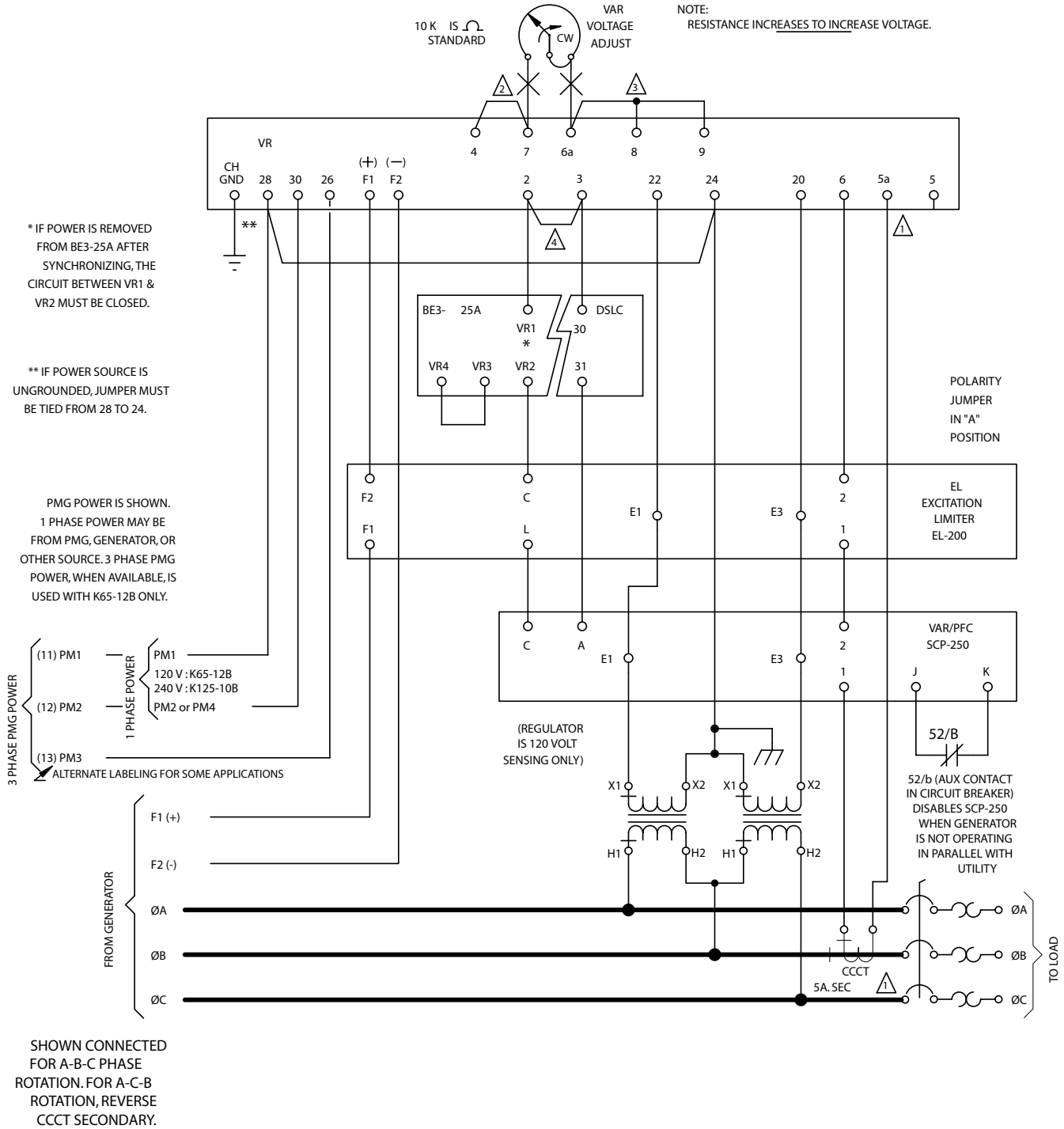

Figure 2: Regulator connections (three phase)

NOTES:

- 1 IF 1A. SEC CCCT IS USED, CONNECT TO TERMINAL 5 INSTEAD OF 5a. (VAR/PFC & EL CANNOT BE USED WITH 1A. CCCT).
- 2 IF EXTERNAL VAR IS NOT USED, JUMPER 4 TO 7.
- 3 FOR 2 x V/HZ, REMOVE CONNECTION TO TERMINAL 8. (1 x V/HZ CONNECTION IS SHOWN).
- 4 IF EL, VAR/PF, DSLC AND/OR BE3-25A ARE NOT USED, JUMPER 2 TO 3.

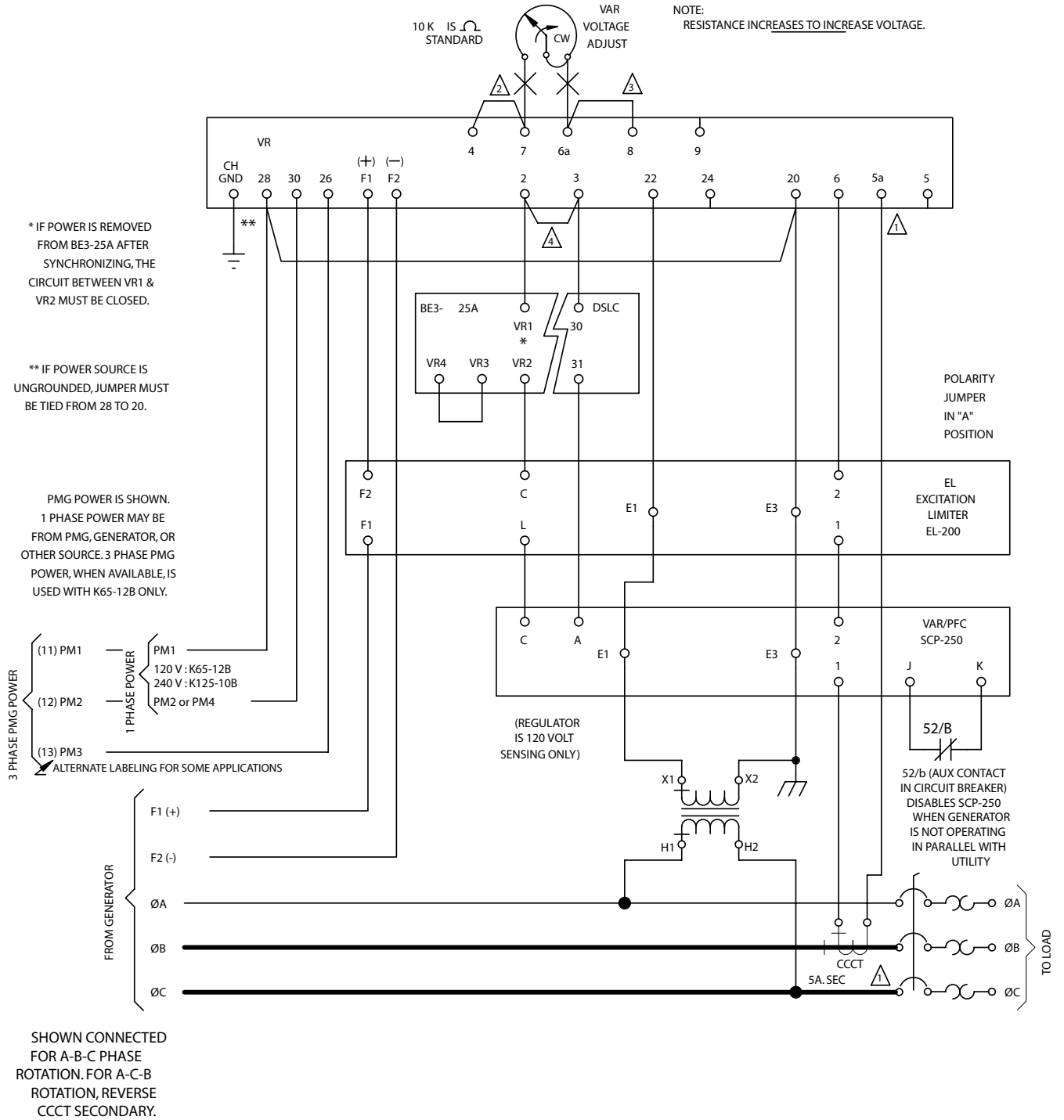

Figure 3: Regulator connections (single phase)

NOTES:

- 1. IF 1A. SEC CCCT IS USED, CONNECT TO TERMINAL 5 INSTEAD OF 5a. (VAR/PFC & EL CANNOT BE USED WITH 1A. CCCT).
- 2. IF EXTERNAL VAR IS NOT USED, JUMPER 4 TO 7.
- 3. FOR 2 x V/HZ, REMOVE CONNECTION TO TERMINAL 8. (1 x V/HZ CONNECTION IS SHOWN).

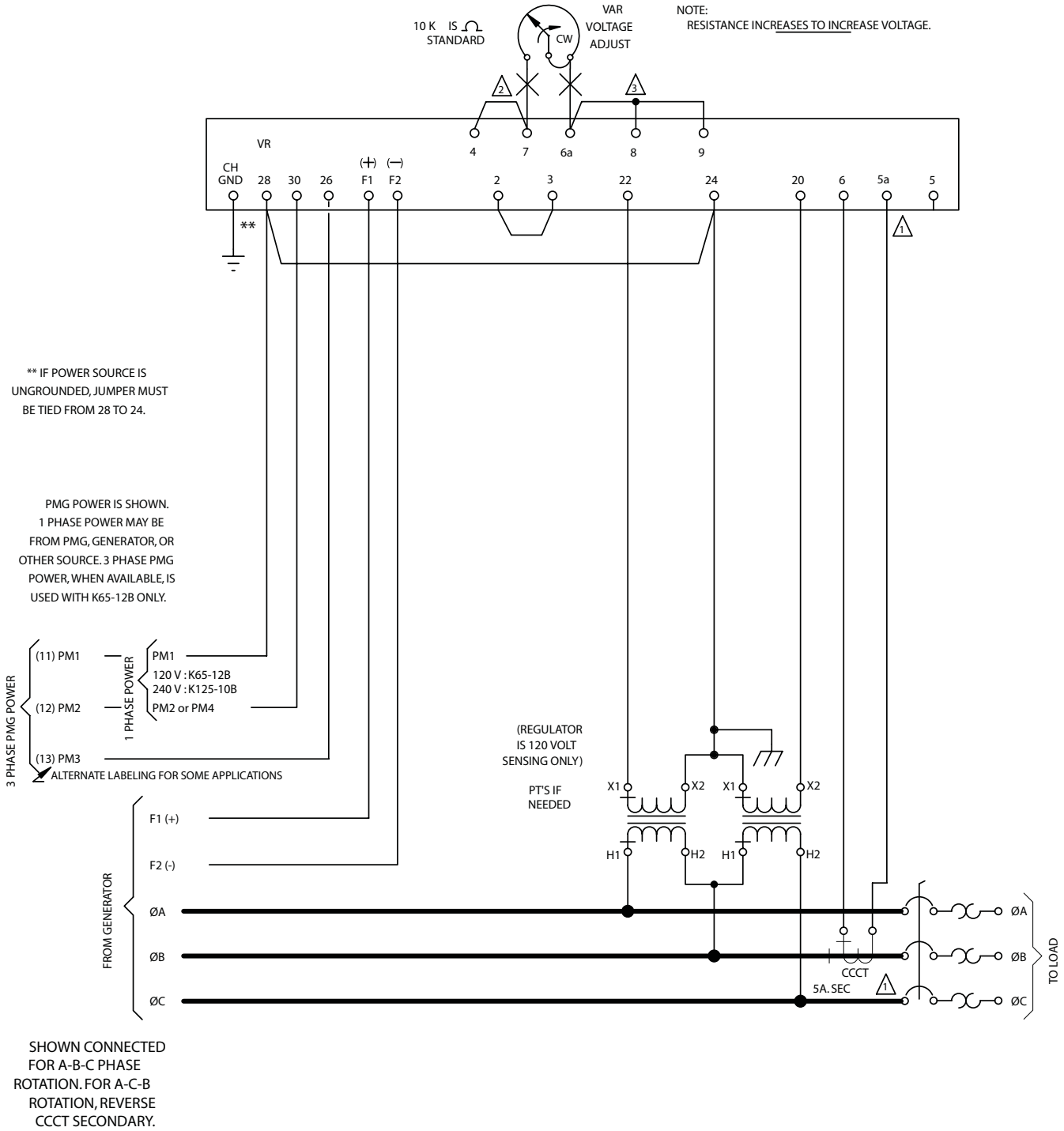

Figure 4: Regulator connections (simple three phase)

NOTES:

- 1 IF 1A. SEC CCCT IS USED, CONNECT TO TERMINAL 5 INSTEAD OF 5a. (VAR/PFC & EL CANNOT BE USED WITH 1A. CCCT).
- 2 IF EXTERNAL VAR IS NOT USED, JUMPER 4 TO 7.
- 3 FOR 2 x V/HZ, REMOVE CONNECTION TO TERMINAL 8. (1 x V/HZ CONNECTION IS SHOWN).

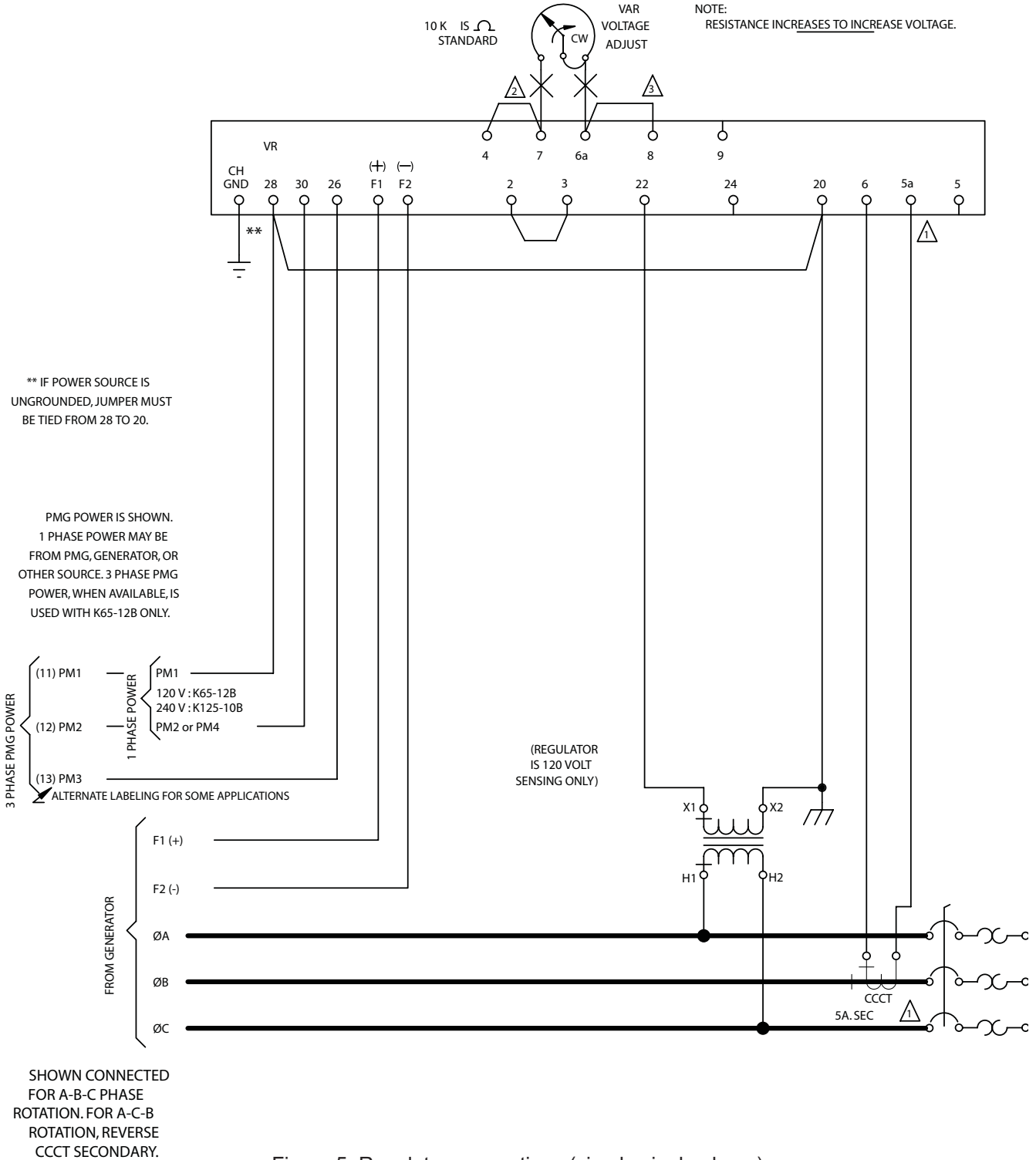

Figure 5: Regulator connections (simple single phase)

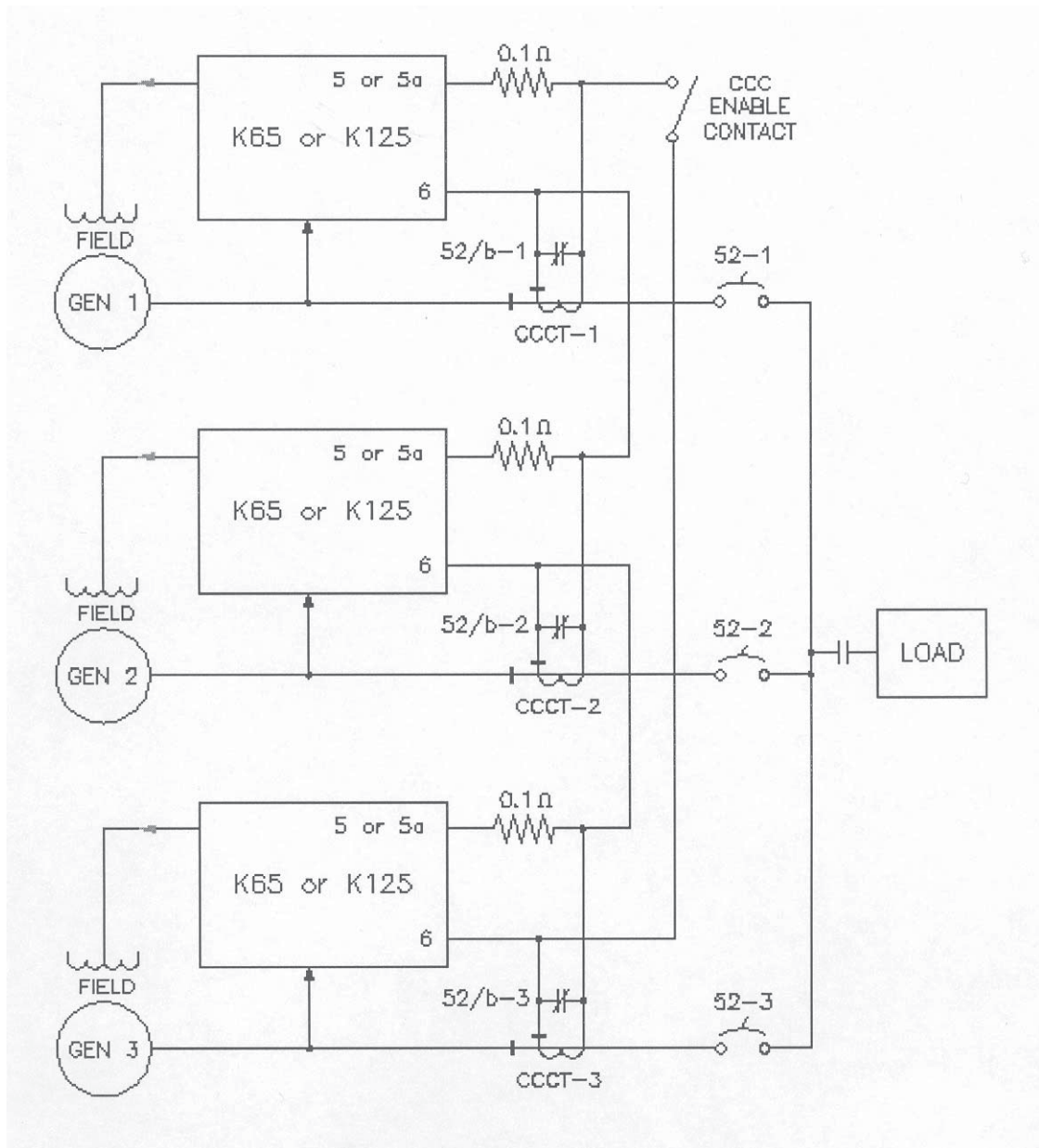

Figure 6: Cross-current compensation

Operation

General

Table 5 provides system start-up procedures for the K65-12B and K125-10B voltage regulators. Symptoms of problems occurring during start-up that arise from incorrect regulator adjustment and certain generator system problems that resemble faulty regulation are included together with possible solutions. Simplifying the system by eliminating components, such as remote adjust potentiometers and other non-essential items can be helpful in the troubleshooting process. Adjustments, options, and an operational test are included in the paragraphs after the table.

Preliminary Setup

To prevent damage to the regulator, ensure that the regulator has been installed and connected in accordance with the installation procedures before proceeding with the system start-up.

System Startup

Refer to Table 5 for starting up the system

Procedure	Symptom	Remedy
1. Perform the preliminary set-up.	N/A	N/A
2. Start prime mover and bring up to rated speed.	a. Voltage does not build-up	a. Flash field. (Except with PMG) b. Remove power for 1 minute to allow the over excitation circuit to reset. c. Troubleshoot.
	b. Voltage builds up and then decays	a. Troubleshoot.
3. Slowly adjust VLT ADJ or external voltage adjust rheostat until voltage reaches nominal.	a. Voltage does not build up to rated value	a. Check generator output for shorted or excessive load. b. Troubleshoot.
	b. Voltage high and uncontrollable	a. Troubleshoot.
4. Apply and remove load to check stability.	Generator response too slow or is hunting (oscillating)	a. Check generator output for shorted or excessive load. Adjust STB with no load applied. b. Check stability of governor system. c. Troubleshoot.
5. Check regulation under normal operating conditions.	Poor regulation	a. Check that prime mover is up to speed. b. Check that voltmeter is connected at the same point as the regulator sensing. c. Use an average sensing voltmeter (not a RMS sensing). d. Troubleshoot.
6. Reduce generator frequency. Generator output should decrease from this point.	Generator output voltage does not decrease at desired frequency	a. Check that all wiring is in accordance with the installation procedures b. Adjust UF control.

Table 5: System startup

Adjustments

For location of the adjustments referenced in the following paragraphs, refer to Figure 1.

Field Flashing (only for units with no PMG)

When the regulator is operated with the generator for the first time, the polarity of the residual magnetism may not be correct or of sufficient magnitude. If the generator residual voltage is less than 6 Vac for the K65-12B or 12 Vac for the K125-10B at terminals 26 and 28, shut down the prime mover and proceed with the following steps:

Caution: Do not flash the field with the generator in motion. The regulator may be damaged.

- (1) With the prime mover at rest, apply a DC source (ungrounded), of not more than 24 Vdc, to terminals F1 (positive) and F2 (negative) in series with a limiting resistor. Use 1 ohm of resistance for each volt from the DC power source with a power rating of least one 1 watt per ohm.

Example: If using a 24 Vdc source, use a 24-ohm, 24-watt resistor.

- (2) Allow the field to be flashed for approximately 10 seconds before removing the DC source.
- (3) If voltage build-up does not occur after performing steps (1) and (2), verify the polarity of the DC source used in steps (1) and (2) and re-perform.

Frequency roll-off (knee) adjustment (Not on 810-34334-00)

The underfrequency knee can be set for 45 to 60 Hz operation as described in the following paragraphs.

- (1) Adjust the underfrequency potentiometer (UF) fully CCW.
- (2) Set the generator to the desired frequency
- (3) Adjust the Voltage Adjust (internal or external) for nominal generator voltage.
- (4) Adjust the underfrequency potentiometer (UF) CW until the voltage begins to decrease.
- (5) Adjust the underfrequency potentiometer (UF) CCW until the voltage just returns to the value set in Step 3.
- (6) The underfrequency “knee” is now set just below the nominal operating frequency. Further rotation in the CCW direction will lower the frequency at which underfrequency compensation begins.
- (7) Connecting a jumper from terminal 8 to terminal 6a will provide an underfrequency slope of 1 X V/Hz. No connection to terminal 8 will result in an underfrequency slope of 2 X V/Hz.

Stability (STB) adjustment

Use an oscilloscope or other voltage-recording device if an optimal stability setting is desired. Adjust the stability setting with the generator at no load. Good response can be obtained with the following procedure.

- (1) Rotation of the STB control in the clockwise (CW) direction will slow response time.
- (2) Rotation of the STB control in the counter-clockwise (CCW) direction will speed response time. If rotated too far CCW, the generator voltage may oscillate (hunt).
- (3) Rotate the front panel STB control CCW until the system just begins to oscillate and then rotate CW just past the point where oscillation occurred.

Voltage (VLT ADJ) adjustment

- (1) Installation of a jumper across terminals 4 and 7 allows the internal VLT ADJ adjustment to vary the generator nominal voltage over the operating range.
- (2) Remove the jumper between terminals 4 and 7 and connect a 10k ohm external voltage adjust potentiometer across terminals 6 and 7 to allow operation of the external voltage adjust potentiometer. The internal voltage adjustment should be set fully CW for proper operation of the external adjustment.

Caution: *The factory calibration (FAC CAL) adjustment is intended for use by factory technicians only. The factory voltage adjust range calibration adjustment can be used if the factory calibration has been disturbed.*

Factory voltage adjust range calibration adjustment

With the voltage regulator operating on a generator, adjust the calibration potentiometer fully ccw and the voltage adjust potentiometer fully CW. Adjust the calibration potentiometer CW until the generator voltage is 144 ± 1 Vac. Adjust the voltage adjust CCW and verify the generator voltage is less than 90 Vac. The unit is calibrated and the calibration potentiometer can be sealed.

Parallel droop (DRP) compensation

Variable parallel droop compensation levels can be obtained by adjusting the droop potentiometer. CW rotation increases the amount of droop for a given condition.

Options

The K65-12B and the K125-10B may be equipped with the following options to enhance operational characteristics. Characteristics of these options are defined in the following paragraphs:

Remote voltage adjust

Connect a 10k ohm potentiometer from terminals 6 to 7, remove the jumper from terminal 4 to 7 and adjust the internal voltage adjust potentiometer fully clockwise to allow operation of a remote voltage adjust.

Excitation disable

This option provides for disabling of the excitation system by removal of power from the voltage regulator. A switch removing voltage from terminals 26, 28 and/or 30 will remove power.

Var/PF control

This option allows the K65-12B and the K125-10B to either regulate the volt-amps reactive (var) or power factor while the generator is connected to an infinite or utility bus. The var/PF option (Model Number SCP250G-50 for 50-Hz operation or SCP250G-60 for 60-Hz operation) supplies a DC signal into the K65-12B & K125-10B terminals 2 and 3 to regulate to the SCP250 var or power factor setting.

Manual voltage control

This option provides a manual back-up channel for manually controlling the generator output during generator start-up and commissioning or in the unlikely event that the voltage regulator should fail. Manual voltage controller models MVC-300 (if exciter field current does not exceed 7 amps) or the MVC-112 are suitable for use with either the K65-12B or the K125-10B.

Operational Test

To operationally test any K65-12B or the K125-10B, perform the following steps:

- a. Connect the voltage regulator as shown by Figure 7, and apply 120 Vac.
- b. Adjust the VLT ADJ control fully counterclockwise (CCW).
Result: Observe that the lamp is OFF.
- c. Adjust the front panel VLT ADJ control clockwise (CW).
Result: Observe that the lamp is now ON.
- d. Adjust the front panel VLT ADJ control until the lamp just goes out.

Regulator operation is satisfactory if the above results are obtained. Stability, however, must be tested with the regulator operating while connected to the generator.

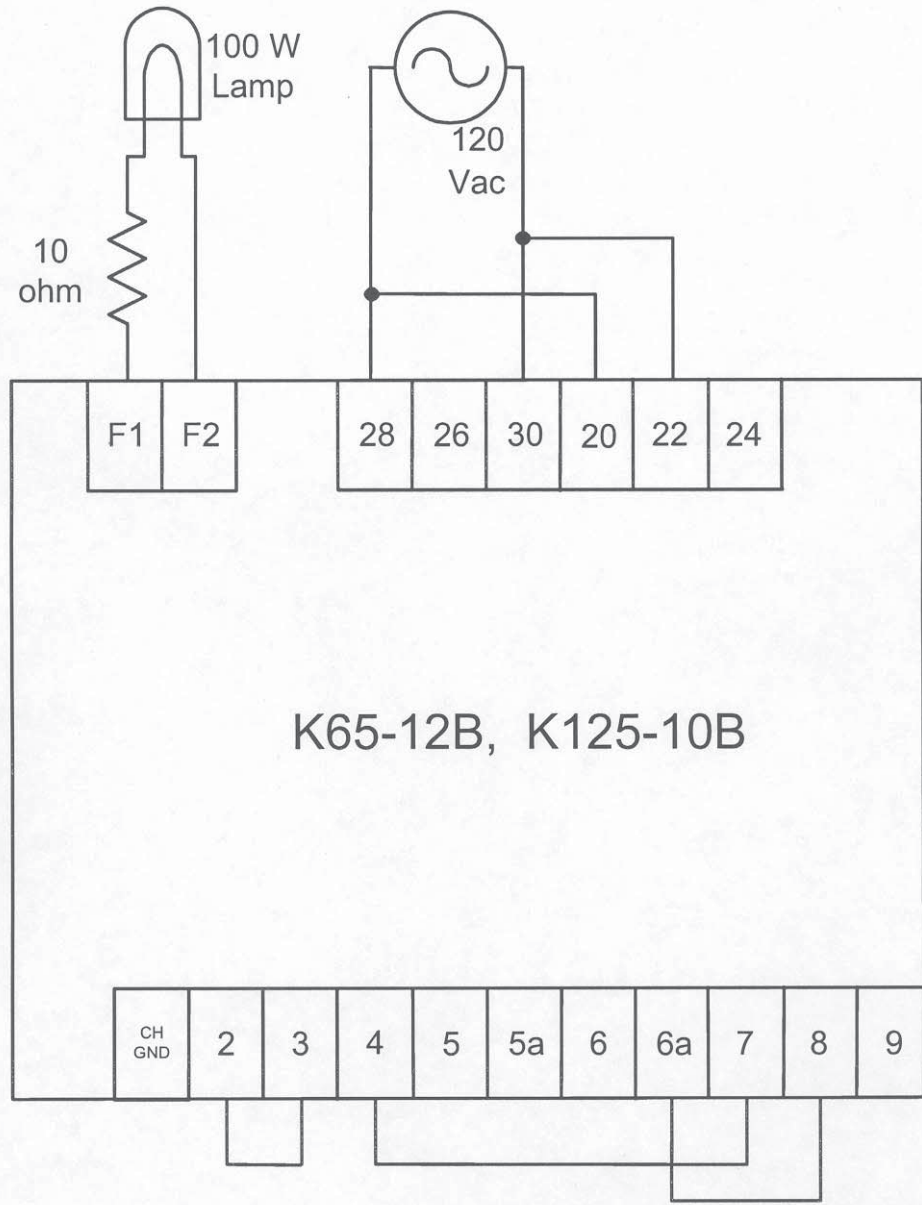

Figure 7: Operational test setup

Maintenance

Preventive Maintenance

Inspect the voltage regulator periodically to ensure that it is clean and free from accumulations of dust and moisture. Be sure that all connections are clean and tight.

Troubleshooting

In case of failure or defective operation of the unit, Table 6 is provided to aid in the determination of the cause and the possible solution.

Simplifying the system by eliminating components, such as remote adjust potentiometers and other non-essential items can be helpful in the troubleshooting process.

Symptom	Possible Cause	Remedy
Voltage does not build up.	a. No voltage or incorrect voltage to power input at terminals 26, 28 or 30	a. Flash field. (except with PMG) b. Verify wiring. c. Check fuses supplying power. d. Replace regulator.
	b. Overexcitation circuit is shutting off regulator	Shutdown regulator power for 1 minute then restart. Watch for high field voltage.
Voltage builds up and then decays.	a. Single or three phase jumper incorrect	Verify single or three phase sensing is applied to 20, 22 and/or 24 and verify connection from upper terminal 6a to 9 is correct.
	b. Defective regulator.	Replace regulator.

Voltage does not build up to rated value.	a. Single or three phase jumper incorrect	Verify single or three phase sensing is applied to 20, 22 and/or 24 and verify connection from terminal 6a to 9 is correct.
	b. Internal or external voltage adjustments are improperly set	Adjust VLT ADJ control and/or external voltage adjust rheostat. Verify proper connection from 4 to 7.
	c. The regulator is operating on the underfrequency curve	Verify the generator is rotating at the proper frequency. Verify proper adjustment of the underfrequency pot.
	d. Faulty regulator	Replace regulator.
	e. Terminals 2 and 3 are not jumpered and there is no device connected to these terminals	a. Jumper terminals 2 and 3. b. Connect var/PF controller or other device to terminals 2 and 3.
	f. Jumpers are set for single-phase sensing and three-phase voltage is applied	Install a jumper between terminals 6a and 9.
Voltage does not build up to rated value. (continued)	g. Voltage adjust pot not in use and terminals 4 and 7 are not jumpered	Install jumper.
Voltage high and uncontrollable.	a. No sensing input	Verify wiring.
	b. Single or three phase jumper incorrect	Verify whether single or three phase sensing is applied to 20, 22 and/or 24 and verify connection from terminal 6a to 9 is correct.
	c. Faulty regulator	Replace regulator.
	d. Voltage adjust pot in use and terminals 4 and 7 are still jumpered	Remove jumper.
Generator response too slow or hunting.	a. Improper front panel STB adjustment	Re-adjust front panel STB adjustment, as described in section 3.
	b. Improper governor setting	Adjust governor.
	c. Faulty regulator.	Replace regulator.
Poor regulation.	a. Low prime mover speed	Verify prime mover speed.
	b. Faulty regulator	Replace regulator.
No specific symptom; random loss of control	Cross-grounding of circuitry	Remove the connection jumper between terminal 28 and 20 (single-phase sensing) or 24 (three-phase sensing)

Table 6: Troubleshooting